

إقرأ و لون

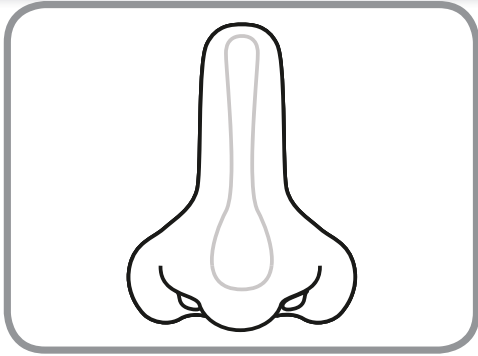

أنف

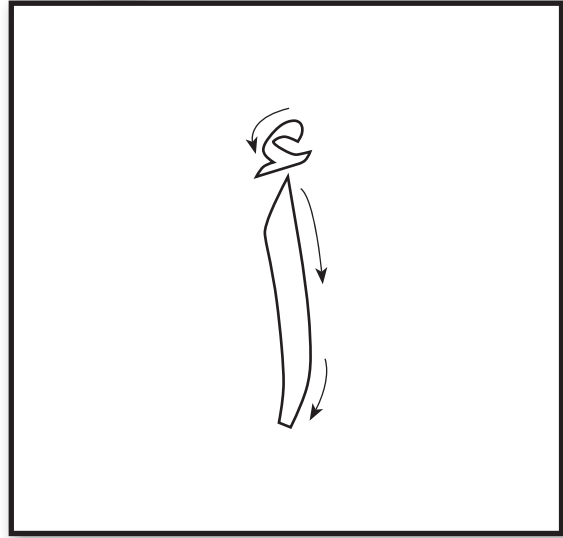
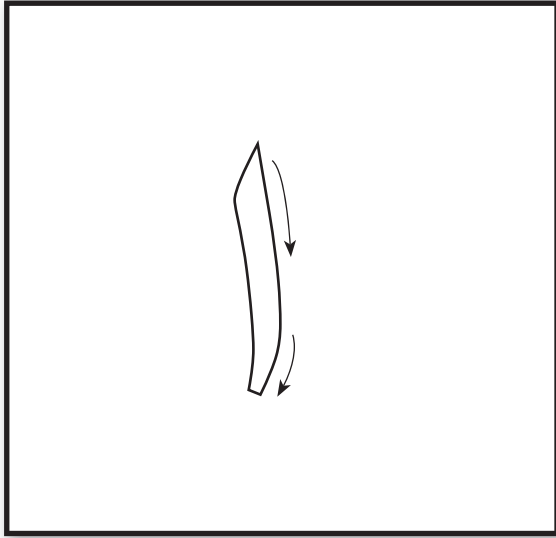
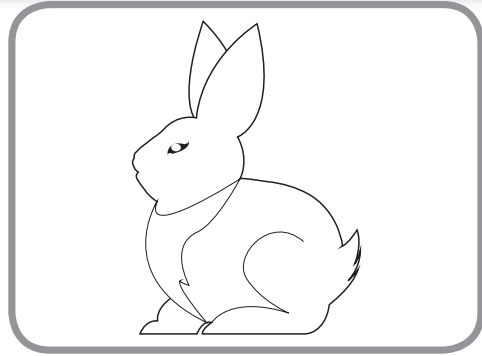

أرنب

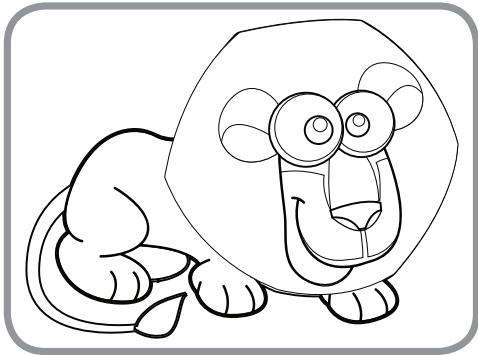

أسد

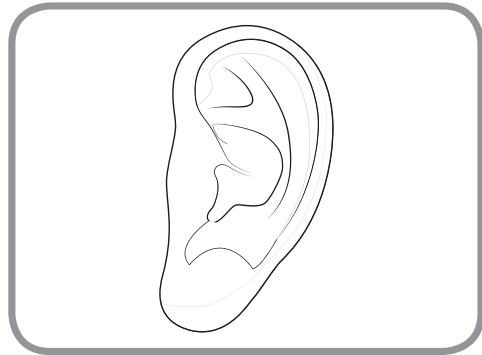

أذن

إقرأ و لون

أ	أ	أ	أ	أ	أ
أ	أ	أ	أ	أ	أ

اكتب الحرف الناقص

أسد

سد

سد

سد

سد

سد

أذن

ذن

ذن

ذن

ذن

ذن

أنف

نف

نف

نف

نف

نف

أرنب

رنب

رنب

رنب

رنب

رنب

إقرأ و لون

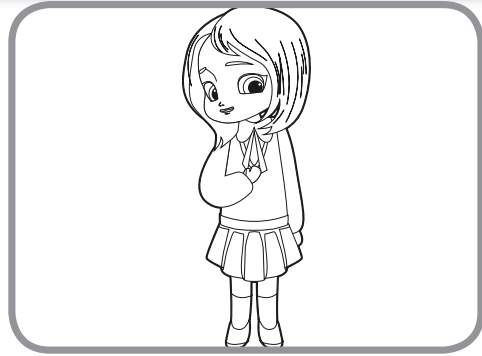
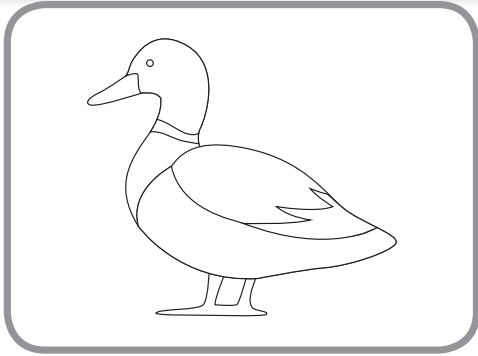
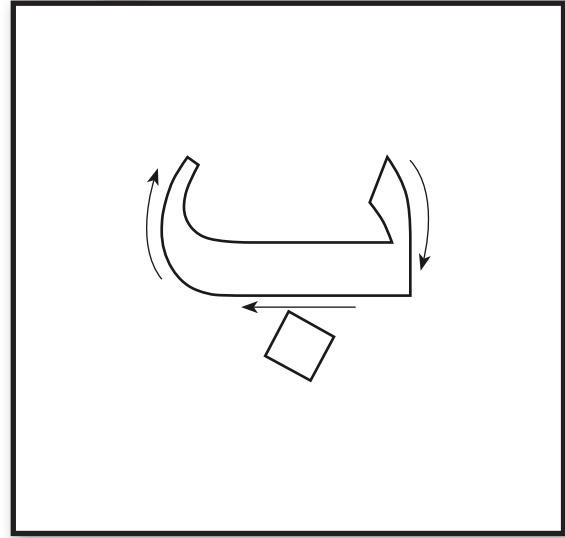
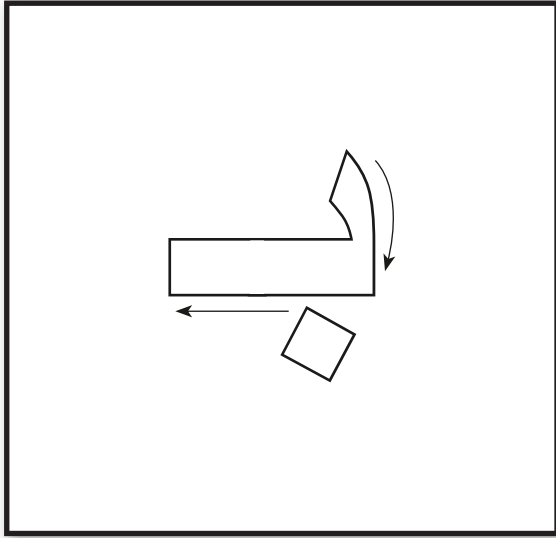

بطة

بنت

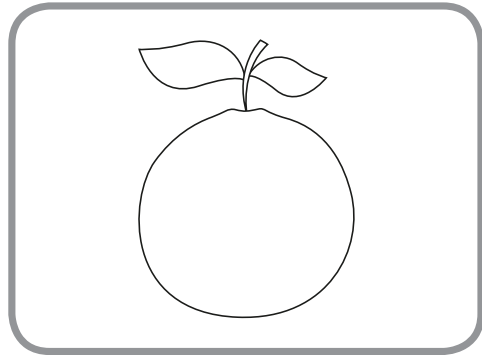
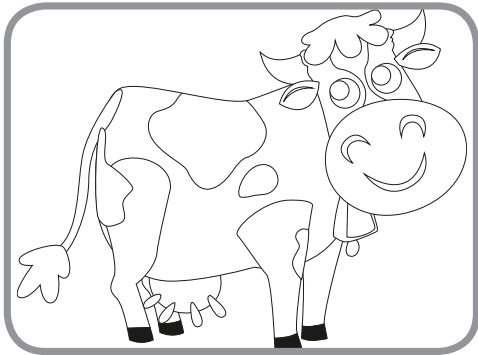

بقرة

برتقالة

إقرأ و لون

ب	ب	ب	ب	ب	ب
ب	ب	ب	ب	ب	ب

اكتب الحرف الناقص

بقرة

قـرة.....

قـرة.....

قـرة.....

قـرة.....

قـرة.....

برتقالة

رـتقالة.....

رـتقالة.....

رـتقالة.....

رـتقالة.....

رـتقالة.....

بطة

طـة.....

طـة.....

طـة.....

طـة.....

طـة.....

بنت

نـت.....

نـت.....

نـت.....

نـت.....

نـت.....

إقرأ و لون

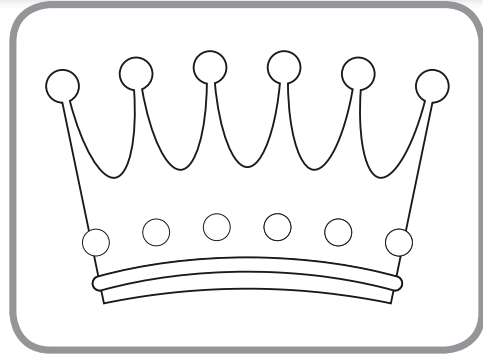
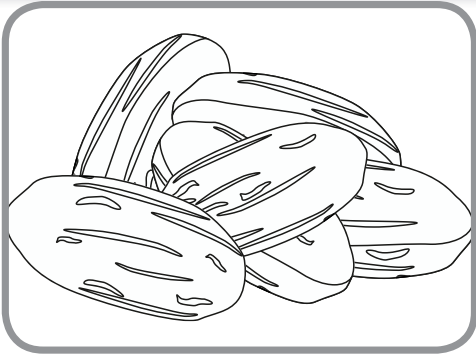
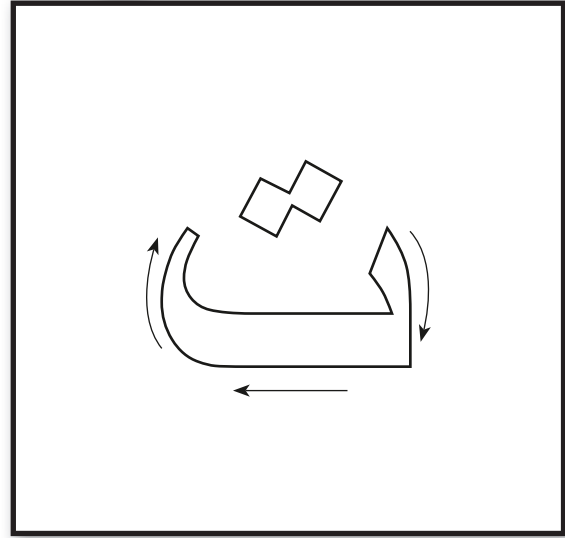
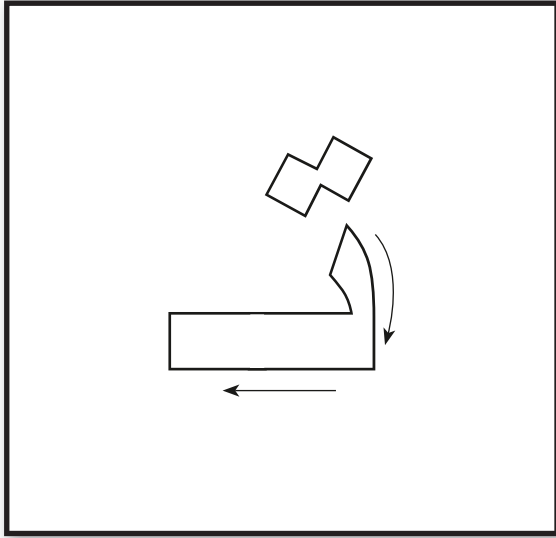

قمر

قاج

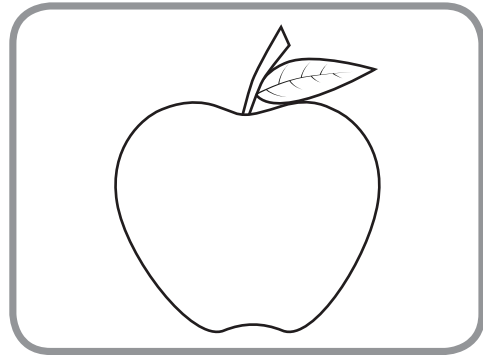
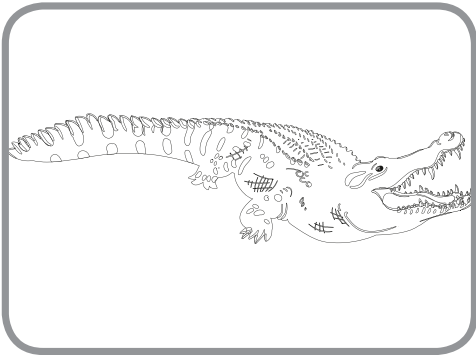

قمساح

قفاحة

إقرأ و لون

ت	ت	ت	ت	ت	ت
ت	ت	ت	ت	ت	ت

اكتب الحرف الناقص

تمساح

..... مساح

..... مساح

..... مساح

..... مساح

..... مساح

تفاحة

..... فاحة

..... فاحة

..... فاحة

..... فاحة

..... فاحة

تمر

..... مر

..... مر

..... مر

..... مر

..... مر

تاج

..... اج

..... اج

..... اج

..... اج

..... اج

إقرأ و لون

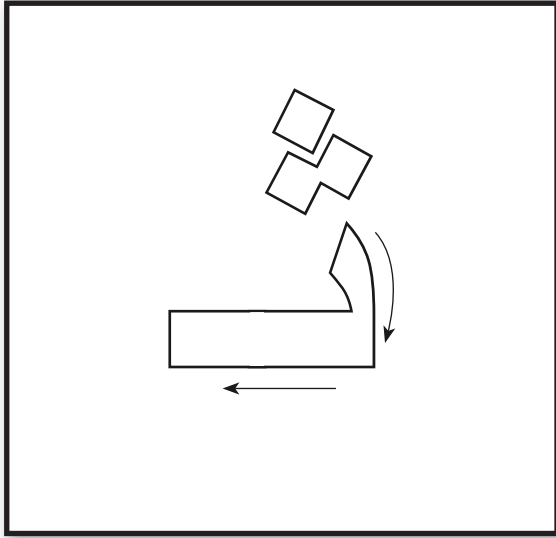

ثوب

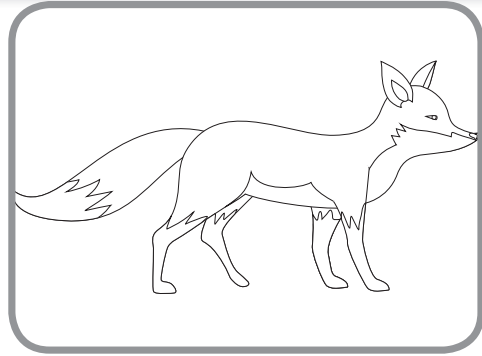
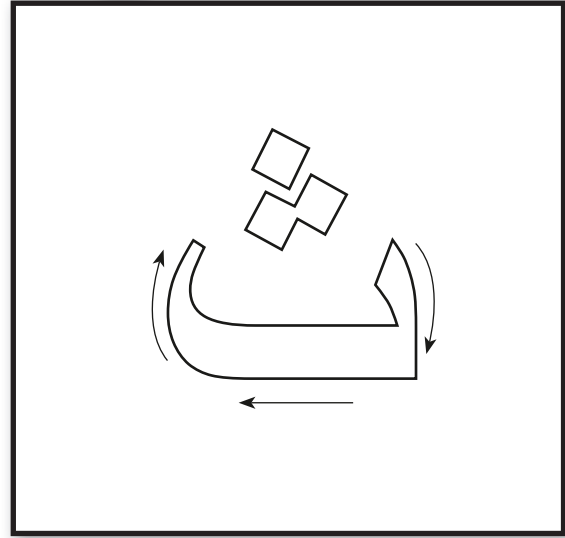

ثعلب

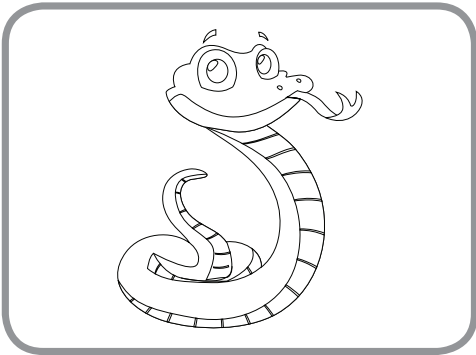

ثعبان

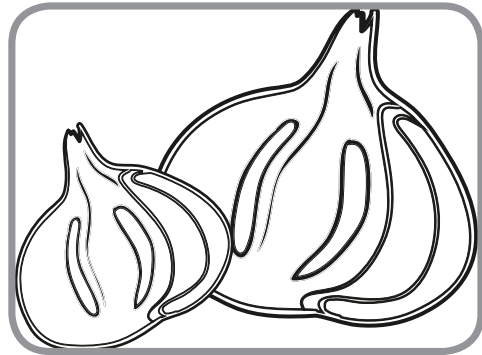

ثوم

إقرأ و لون

ث	ث	ث	ث	ث	ث
ث	ث	ث	ث	ث	ث

اكتب الحرف الناقص

ثعبان

.....عبان

.....عبان

.....عبان

.....عبان

.....عبان

ثوم

.....وم

.....وم

.....وم

.....وم

.....وم

ثوب

.....وب

.....وب

.....وب

.....وب

.....وب

ثعلب

.....علب

.....علب

.....علب

.....علب

.....علب

اكتب الحرف الأول لكل صورة

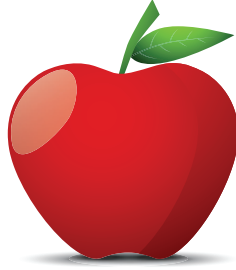

صل بين الصورة والكلمة المناسبة

أذن



تاج

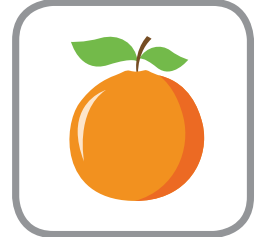

ثعبان



برتقالة



ضع دائرة حول الحرف المناسب لكل صورة ثم لونها

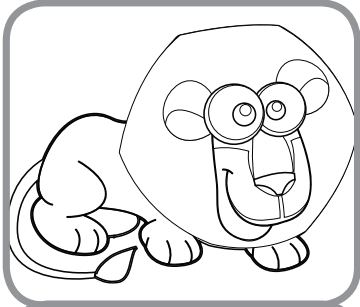

ت أ ب

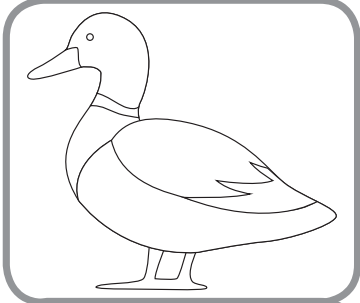

ت ب ث

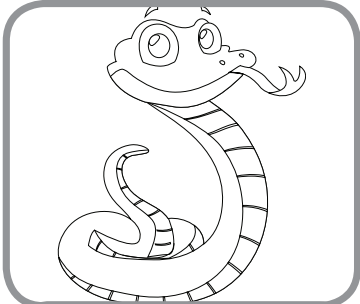

ث أ ب

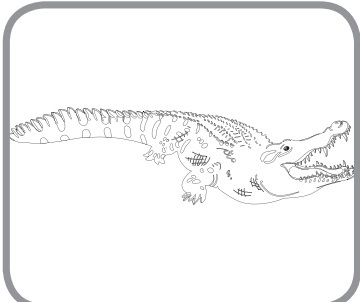

ب ت أ

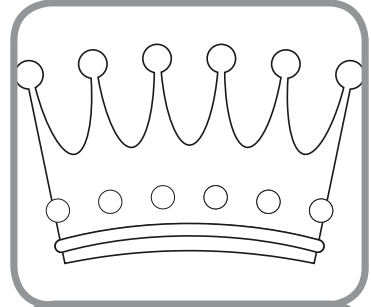

أ ت ث

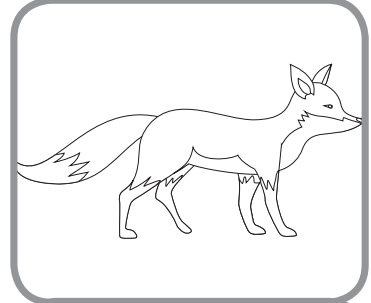

ث أ ب

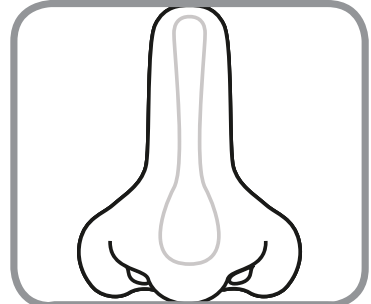

ن ف أ

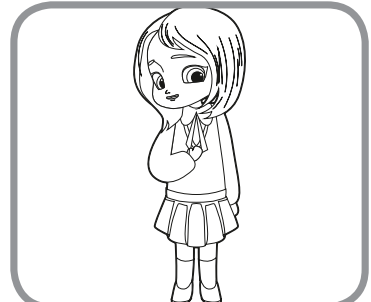

ث ب ت

إقرأ و لون

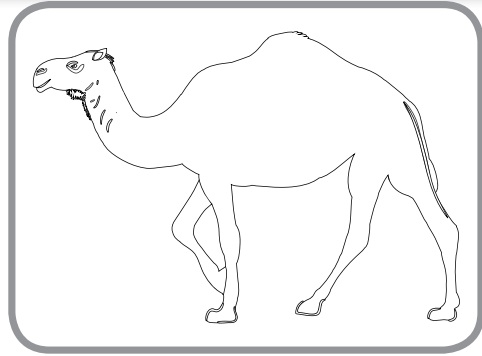
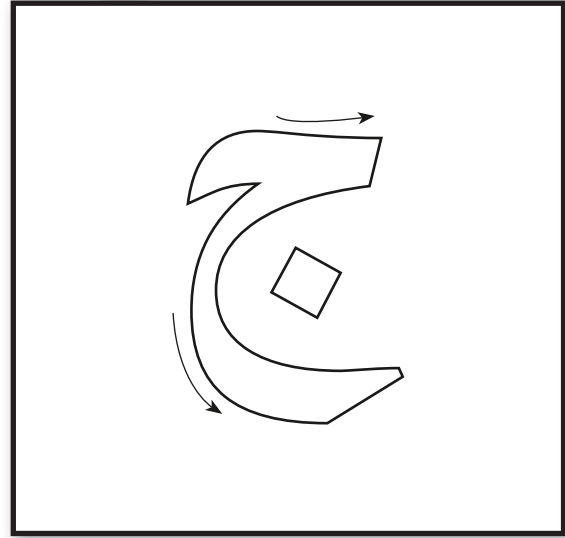
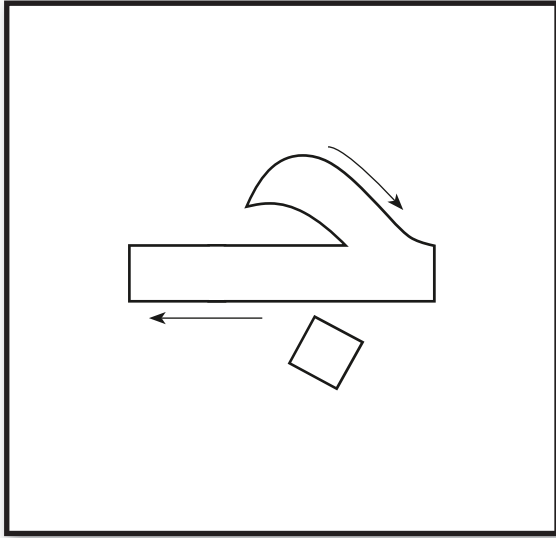

جزر

جمل

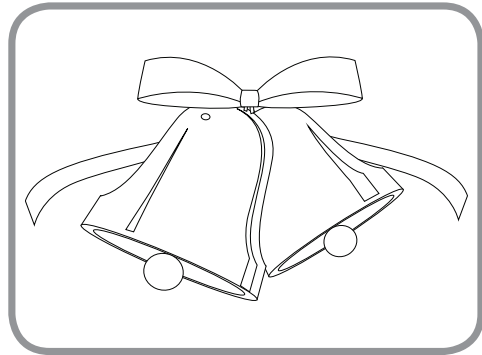
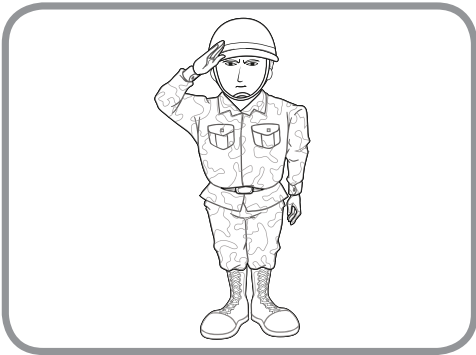

جندي

جرس

إقرأ و لون

ج	ج	ج	ج	ج	ج
ج	ج	ج	ج	ج	ج

اكتب الحرف الناقص

جندي

.....ندي

.....ندي

.....ندي

.....ندي

.....ندي

جرس

.....رس

.....رس

.....رس

.....رس

.....رس

جزر

.....زر

.....زر

.....زر

.....زر

.....زر

جمل

.....مل

.....مل

.....مل

.....مل

.....مل

إقرأ و لون

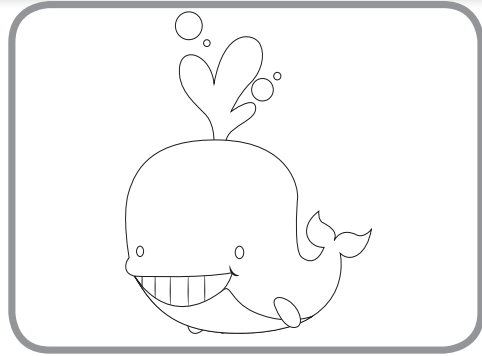
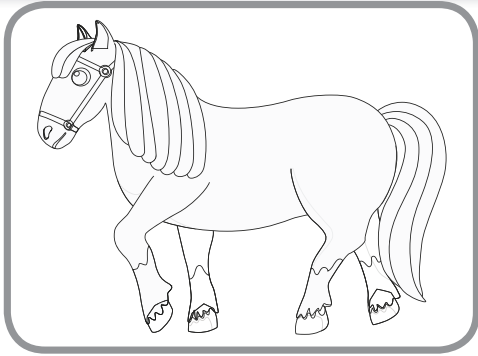
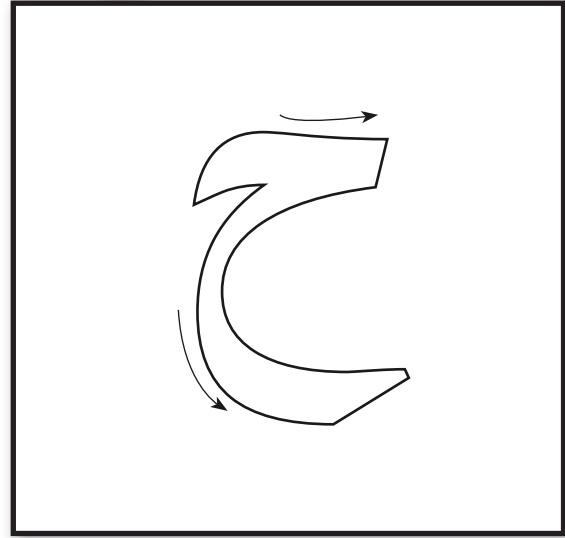
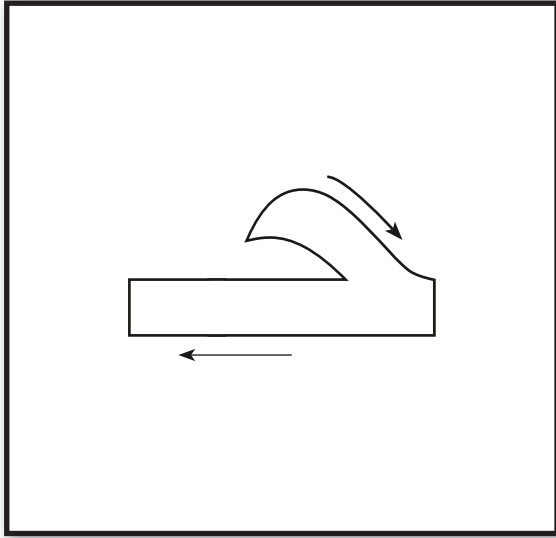

حصان

حوت

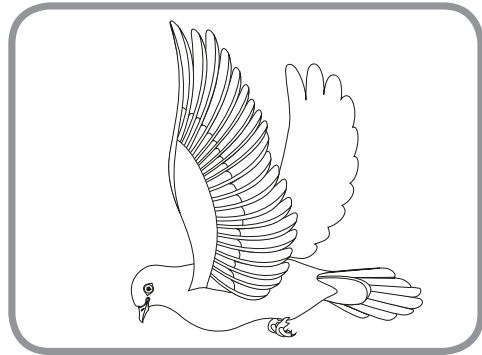

حمية

حمامة

إقرأ و لون

ح	ح	ح	ح	ح	ح
ح	ح	ح	ح	ح	ح

اكتب الحرف الناقص

حقيبة

.....قبة

.....قبة

.....قبة

.....قبة

.....قبة

حمامة

.....مامة

.....مامة

.....مامة

.....مامة

.....مامة

حصان

.....صان

.....صان

.....صان

.....صان

.....صان

حوت

.....وت

.....وت

.....وت

.....وت

.....وت

إقرأ و لون

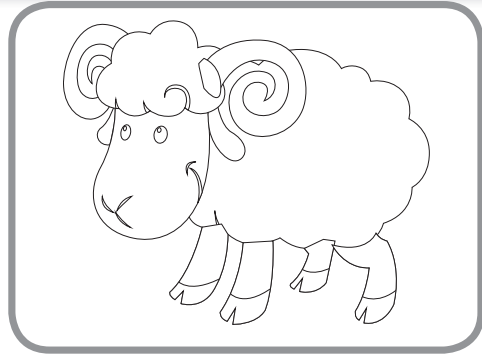
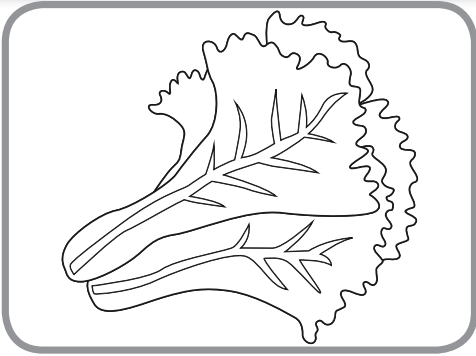
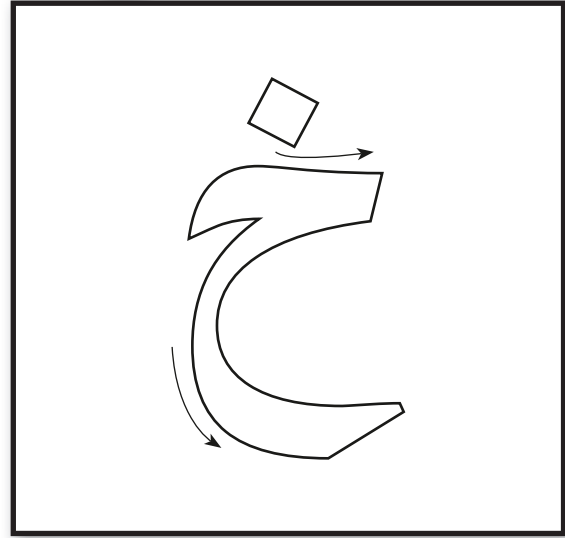
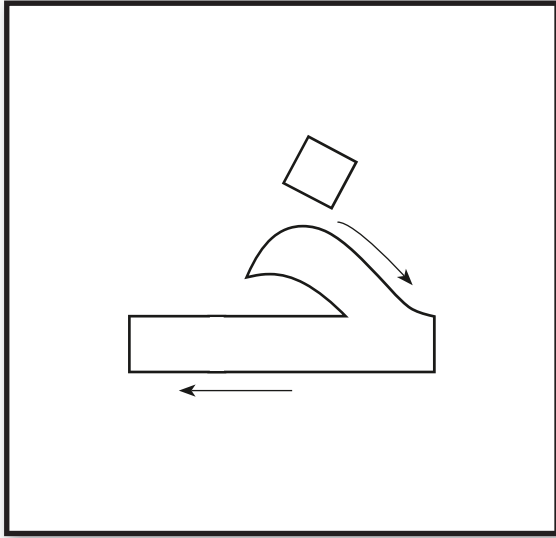

خس

خروف

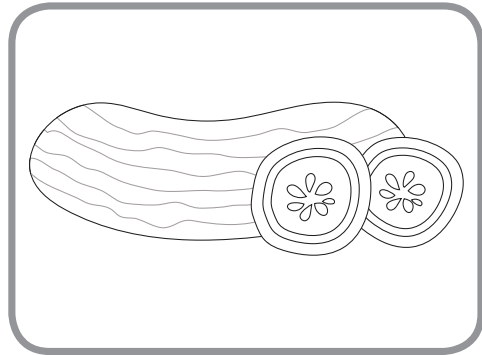
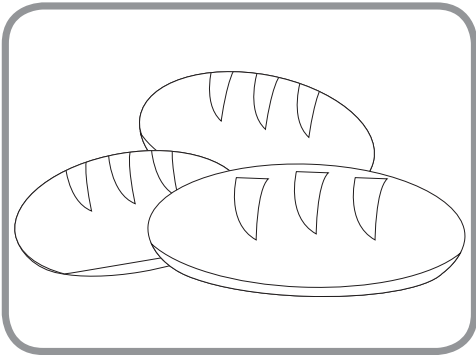

خبز

خيار

إقرأ و لون

خ	خ	خ	خ	خ	خ
خ	خ	خ	خ	خ	خ

اكتب الحرف الناقص

خبز

.....بز

.....بز

.....بز

.....بز

.....بز

خيار

.....يار

.....يار

.....يار

.....يار

.....يار

خس

.....س

.....س

.....س

.....س

.....س

خروف

.....روف

.....روف

.....روف

.....روف

.....روف

اكتب الحرف الأول لكل صورة

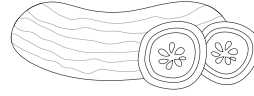
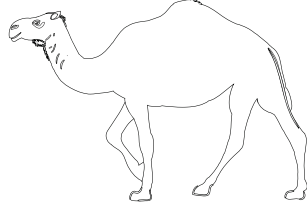
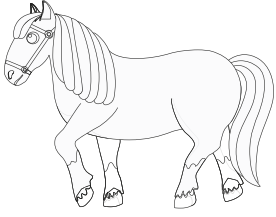

صل بين الصورة والكلمة المناسبة

حمامة

حوت

جزر

خروف

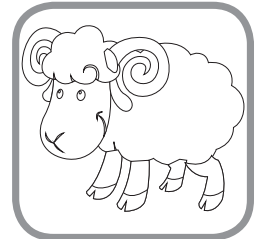
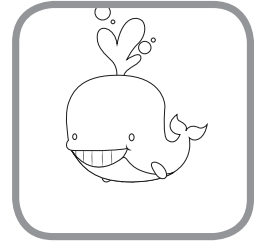

ضع دائرة حول الحرف المناسب لكل صورة ثم لونها



ت ح ب

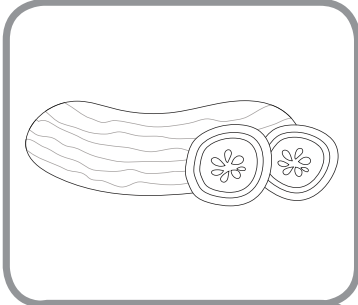

ح خ أ

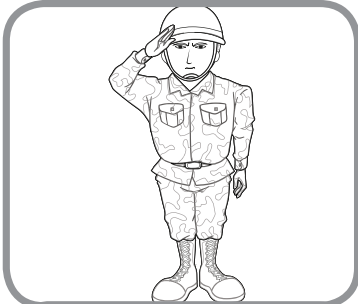

ب أ ج



ب خ ح

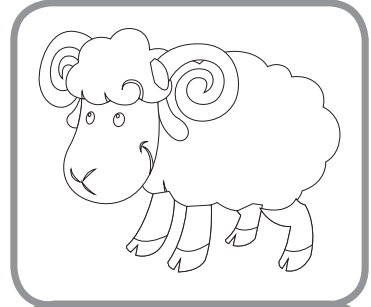

ح ب خ

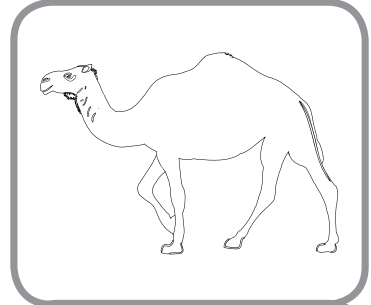

ت ج أ

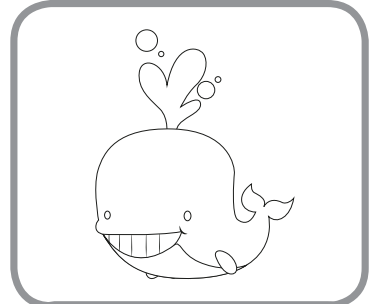

ح ت ث

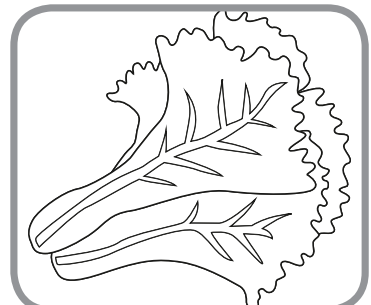

ح ب خ

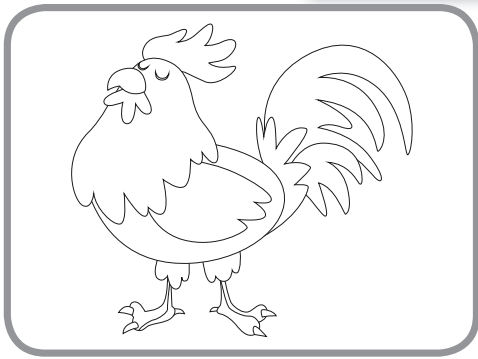

ديك

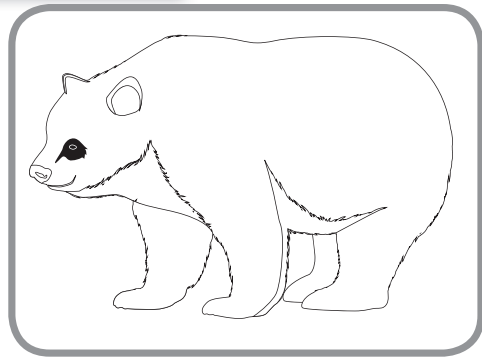

دب

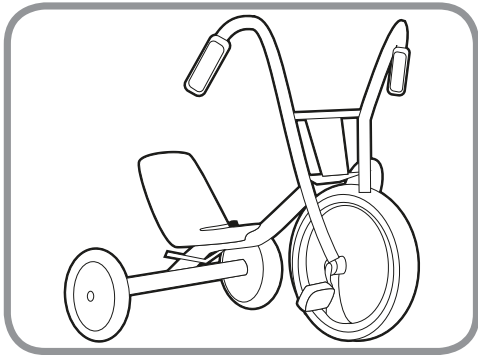

دراجة

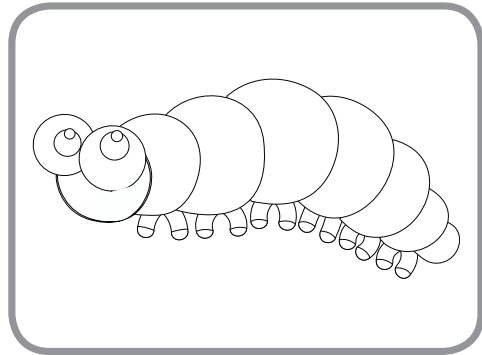

دودة

إقرأ و لون

د	د	د	د	د	د
د	د	د	د	د	د

اكتب الحرف الناقص

دراجة

.....راجة

.....راجة

.....راجة

.....راجة

.....راجة

دودة

.....ودة

.....ودة

.....ودة

.....ودة

.....ودة

ديك

.....يك

.....يك

.....يك

.....يك

.....يك

دب

.....ب

.....ب

.....ب

.....ب

.....ب

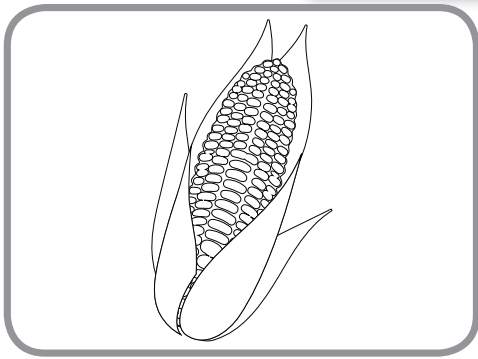
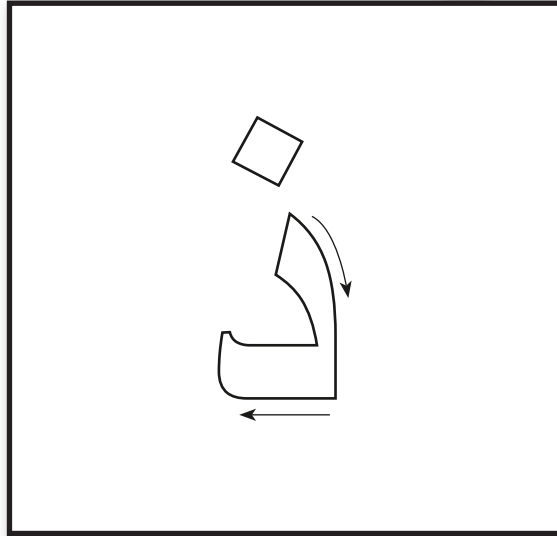

ذرة

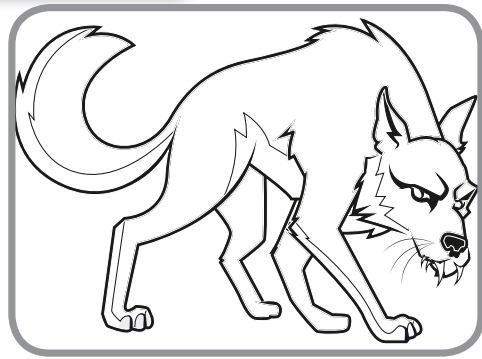

ذئب

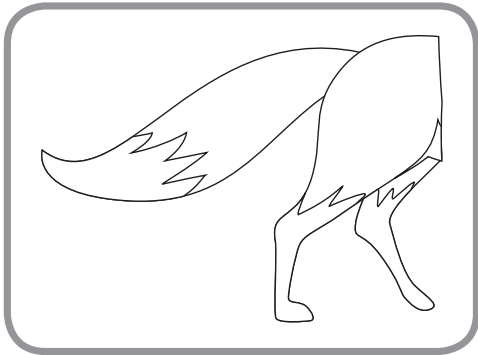

ذيل

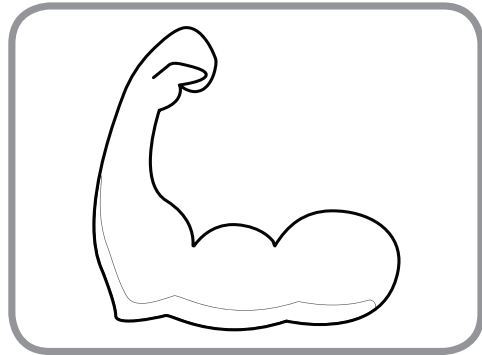

ذراع

إقرأ و لون

ذ	ذ	ذ	ذ	ذ	ذ
ذ	ذ	ذ	ذ	ذ	ذ

اكتب الحرف الناقص

ذيل

.....يل

.....يل

.....يل

.....يل

.....يل

ذراع

.....راع

.....راع

.....راع

.....راع

.....راع

ذرة

.....رة

.....رة

.....رة

.....رة

.....رة

ذئب

.....ئب

.....ئب

.....ئب

.....ئب

.....ئب

اكتب الحرف الأول لكل صورة



صل بين الصورة والكلمة المناسبة

حقيبة

دب

ثوب

ذيل



ضع دائرة حول الحرف المناسب لكل صورة ثم لونها

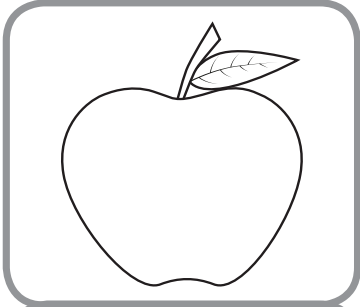

ت ح ب

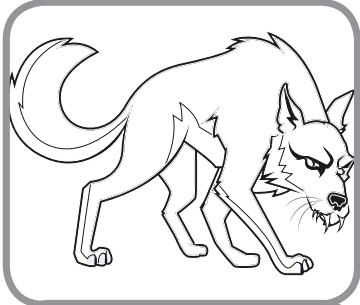

ح خ ذ

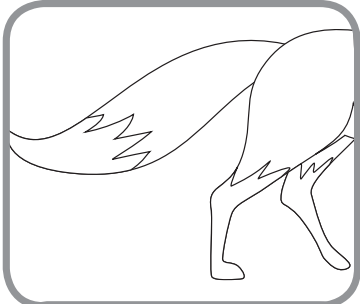

ذ أ ج

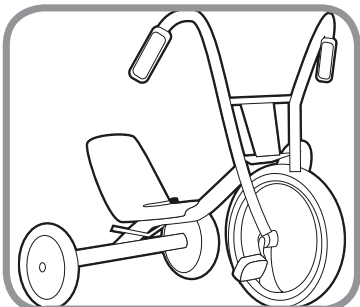

ب د ح

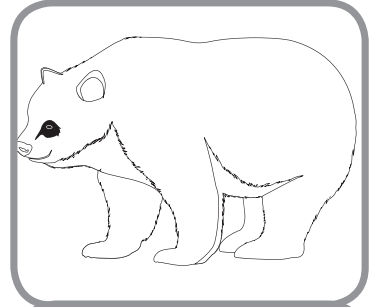

ب أ د

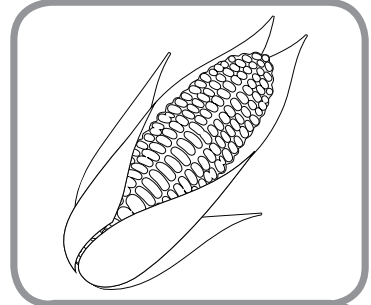

ح ذ ت

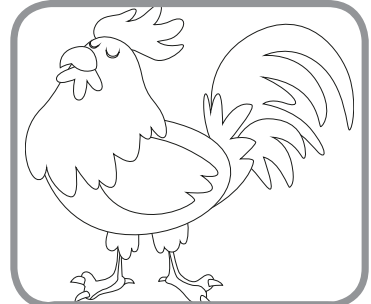

د ت ث

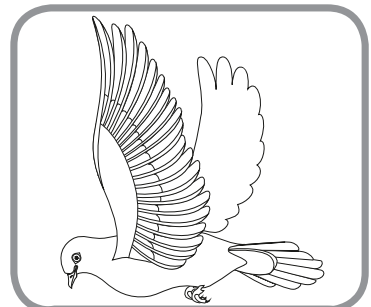

ح ب خ